

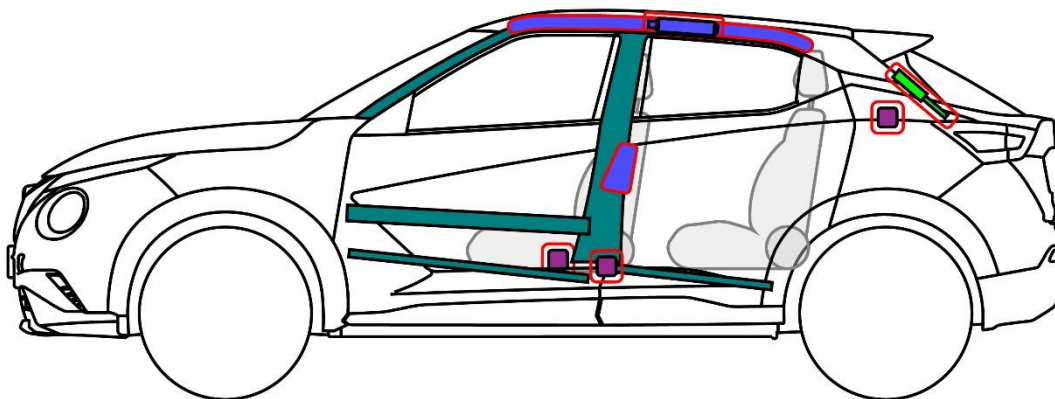

NISSAN

Juke

TYPE: F16, 5-dørs SUV
(2019 -)

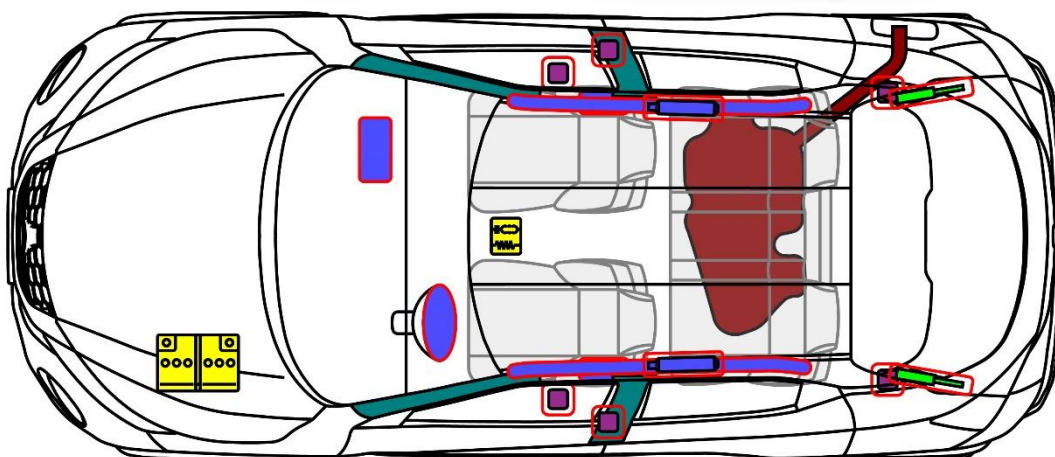

	Airbag		Gasgenerator		Forspænder til sikkerhedssele		SRS kontrolenhed		Aktiv fodgængerbeskyttelse
	Automatisk rullerikring		Gasfjeder / præinstalleret fjeder		Forstærket område		Område, der kræver særlig opmærksomhed		
	Batterispænding lavt		Ultrakondensator, lavspænding		Brændstoftank		Gastank		Sikkerhedsventil
	Batteripakke, højspænding		Højspændingskabel / komponenter		Højspændingsenhed, der afbryder højspænding		Sikringsboks, der deaktiverer højspænding		Højspændingskondensator
	Benzin / ethanol brændstoftank								

1. Identifikation/genkendelse



2. Immobilisering / stabilisering / løft

Immobiliser køretøjet:

1. Blokering af hjul
2. Ved automatisk transmission vælges P (parkering)
3. Indstil parkeringsbremsen
4. Tryk på start/stop-knappen



Løftepunkter:

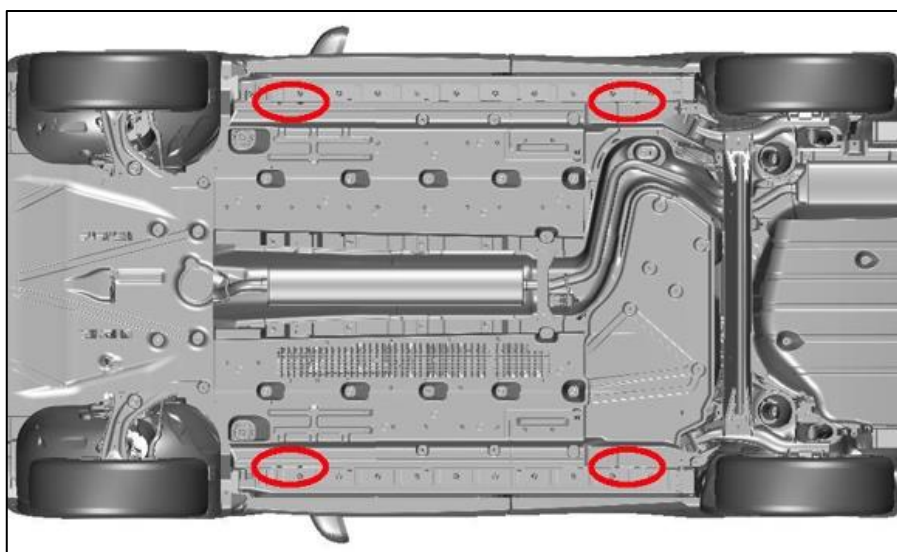

3. Deaktivering af særlige farer / sikkerhedsforanstaltninger

Adgang til motorrummet



Frakobling af 12 volts batteri:

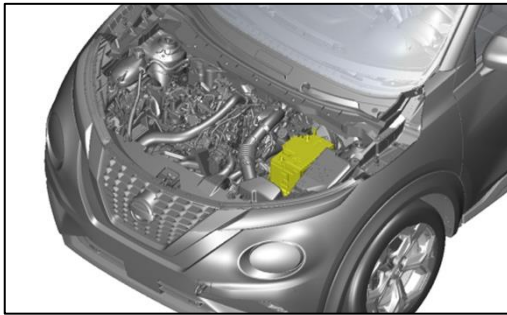
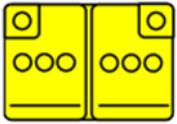

1. Sluk for tændingen
2. Afbryd den negative terminal (-)
3. Afbryd den positive terminal (+)

4. Adgangveje til tilskadekomme

Højstyrkestål i karrosseriet

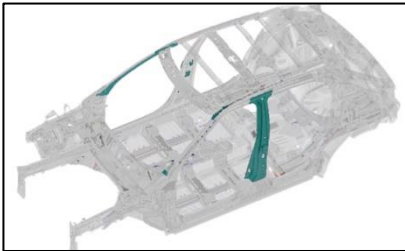

Højstyrkestål i døren

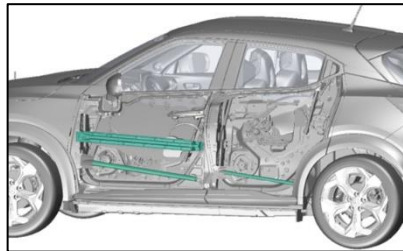

Sædejustering



Justering af ratstamme











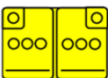

Glastyper:

- A. Lamineret glas.
- B. Hærdet glas.



5. Oplagret energi / væsker / gasser faste stoffer

	12V	 
	R-1234yf 450 ±25 g	   
	46 L	 

6. I tilfælde af brand



BRUG STORE MÆNGDER RENT VAND



GASSTRENGE, RISIKO FOR MISSILEFFEKT

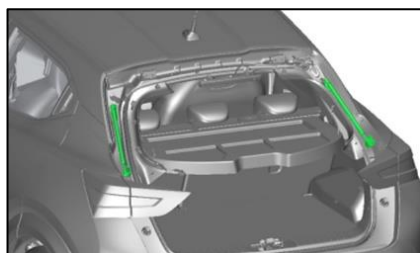

8. Bugsering/transport/opbevaring

Opbevaring af bjærgningskroge



Placering af forreste krog













Placering af bagkrog



Bugsering



10. Piktogram information

	Generelt advarselsskilt		Brandfarlig
	Advarsel; lav temperatur		Farligt for menneskers sundhed
	Klima anlæg		Eksplosiv
	Køretøj på brændstof i klasse 2		Ætsende
	Bonnet		Brug vand til at slukke ilden